



WORKBOOK

MODELING OF COMBUSTION ENGINES

LUBLIN 2014



KAPITAŁ LUDZKI
NARODOWA STRATEGIA SPÓJNOŚCI



UNIA EUROPEJSKA
EUROPEJSKI
FUNDUSZ SPOŁECZNY



Projekt współfinansowany ze środków Unii Europejskiej w ramach Europejskiego Funduszu Społecznego



Author: Jacek Hunicz

Desktop publishing: Jacek Hunicz

Technical editor: Jacek Hunicz

Figures: Jacek Hunicz

Cover and graphic design: Jacek Hunicz

All rights reserved.

No part of this publication may be scanned, photocopied, copied or distributed in any form, electronic, mechanical, photocopying, recording or otherwise, including the placing or distributing in digital form on the Internet or in local area networks, without the prior written permission of the copyright owner.

Publikacja współfinansowana ze środków Unii Europejskiej w ramach Europejskiego Funduszu Społecznego w ramach projektu
Inżynier z gwarancją jakości – dostosowanie oferty Politechniki Lubelskiej do wymagań europejskiego rynku pracy

© Copyright by

Jacek Hunicz, Lublin University of Technology

Lublin 2014

First edition



KAPITAŁ LUDZKI
NARODOWA STRATEGIA SPÓJNOŚCI



UNIA EUROPEJSKA
EUROPEJSKI
FUNDUSZ SPOŁECZNY



Projekt współfinansowany ze środków Unii Europejskiej w ramach Europejskiego Funduszu Społecznego



TABLE OF CONTENTS

	SYMBOLS AND ABBREVIATIONS	4
1.	INTRODUCTION	5
2.	REAL ENGINE CYCLES	5
3.	THEORETICAL ENGINE CYCLES	7
4.	APPROACH TO MODELING	10
5.	PROPERTIES OF THE WORKING FLUIDS	11
6.	GEOMETRY OF THE CRANK MECHANISM	12
7.	INTAKE PROCESS	16
8.	COMPRESSION, COMBUSTION AND EXPANSION	18
9.	EXHAUST PROCESS	21
10.	HEAT TRANSFER	23



KAPITAŁ LUDZKI
NARODOWA STRATEGIA SPÓJNOŚCI



UNIA EUROPEJSKA
EUROPEJSKI
FUNDUSZ SPOŁECZNY



Projekt współfinansowany ze środków Unii Europejskiej w ramach
Europejskiego Funduszu Społecznego



SYMBOLS AND ABBREVIATIONS

A	– Area
A/F	– Air-fuel ratio
c_p	– Specific heat at constant pressure
c_v	– Specific heat at constant volume
c_m	– Average piston speed
CR	– Compression ratio
D	– Diameter
h	– Lift, heat exchange coefficient
IVC	– Intake valve closing
IVO	– Intake valve opening
IMEP	– Indicated mean effective pressure
L_{conr}	– Length of connecting rod
m	– Mass
M	– Individual molar weigh
n	– Number of moles, rotational speed
p	– Pressure
Q	– Heat
Q_{LHV}	– Lower heating value of fuel
r	– Radius
R	– Gas constant
S_{pist}	– Stroke
t	– Time
T	– Temperature
U	– Internal energy
V	– Volume
V_{CC}	– Volume of combustion chamber
V_S	– Swept volume
W	– Work
x	– Fraction, position
a	– Pressure rise ratio, crank angle
β	– Volume rise ratio, critical pressure ratio
γ	– Specific heats ratio
η	– Efficiency
μ	– Flow coefficient



KAPITAŁ LUDZKI
NARODOWA STRATEGIA SPÓJNOŚCI



UNIA EUROPEJSKA
EUROPEJSKI
FUNDUSZ SPOŁECZNY



Projekt współfinansowany ze środków Unii Europejskiej w ramach
Europejskiego Funduszu Społecznego



1. INTRODUCTION

Mathematical modeling is a research tool, which is more and more often used for the analysis of physical and chemical processes occurring in the real technical objects. The purpose of modeling is to make a description of the real object's behavior as a function of affecting factors. Mathematical modeling of piston combustion engine's work cycle is often used for the analysis of phenomena occurring in the engine cylinder. This results from the growing understanding of described processes and their more precise mapping with the use of numerical methods. A large part of this progress is the development of computer technology, due to which in recent years the capabilities of modeling in terms of quickness of calculations and levels of models' complexity have significantly increased. Currently on the market there are many commercial computational packages that enable the simulation of combustion engine work processes. They enable building of both, the zero-dimensional and multi-dimensional engine models with various degrees of complexity. There is also a possibility to integrate the thermodynamic-flow models with chemical reactions models, in order to fully describe the phenomena of charge flow, heat exchange and combustion in the engines.

This course is aimed at development of mathematical model of combustion engine and conducting simulation research of engine's work process. The proposed zero-dimensional model can be implemented in any environment for numerical calculations or in spreadsheet. Despite many simplifications, the model allows for the simulation of significant phenomena occurring in piston engines and for determination of the most important engine parameters.

2. REAL ENGINE CYCLES



KAPITAŁ LUDZKI
NARODOWA STRATEGIA SPÓJNOŚCI



UNIA EUROPEJSKA
EUROPEJSKI
FUNDUSZ SPOŁECZNY



Projekt współfinansowany ze środków Unii Europejskiej w ramach Europejskiego Funduszu Społecznego

The analyses of actual processes occurring in the engine cylinder, based on empirical data, are conducted using the dynamic measurements of thermodynamic parameters in the engine combustion chamber and also in the intake, as well as exhaust runners. The quantity that is available for measuring in the engine combustion chamber is the pressure of the working fluid, called indicated pressure.

The figures 2.1 and 2.2 show exemplary traces of pressure in the cylinder as a function of the position of crankshaft, so called open indicated diagrams. A cursory evaluation of the presented pressure traces in the engine cylinders, allows determining the key differences between the spark-ignition (SI) engines and compression-ignition (CI) engines. SI engines are characterized by lower pressures towards the end of compression, especially at low loads. This is due to the method of engine load control using the throttle and a lower compression ratio. Also, the differences in the combustion process are worth to be noted. In the CI engine, a rapid increase of pressure in the cylinder due to combustion can be noted. To enable the reference of real engine cycle to the theoretical cycle, figures 2.3 and 2.4 show the indicated pressure-volume diagrams. Work process of the engine consists of several essential, consecutive phases:

- intake,
- compression of the working fluid,
- combustion,
- expansion,
- exhaust.

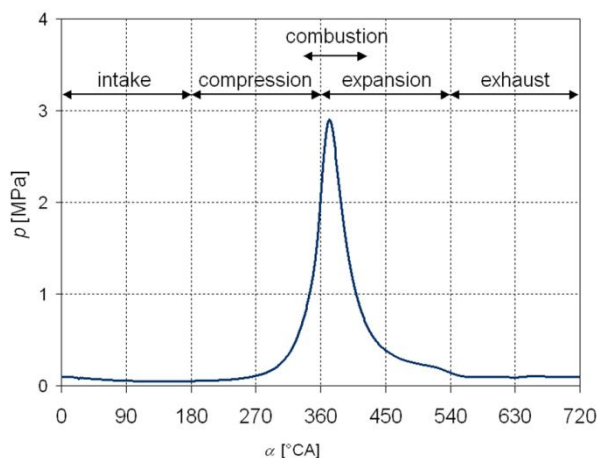

Fig. 2.1. In-cylinder pressure of four-stroke spark-ignition engine at medium engine load

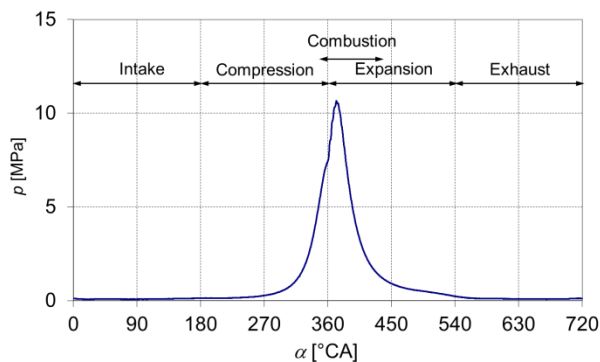

Fig. 2.2. In-cylinder pressure of four-stroke compression-ignition engine with direct fuel injection into the cylinder at medium engine load

Moreover, an important process in the engine work cycle is the formation of air-fuel mixture. Depending on the type of fuel used to provide the energy to the engine and combustion system, this process can take place outside the cylinder or in the cylinder, and includes a phase change of the fuel.

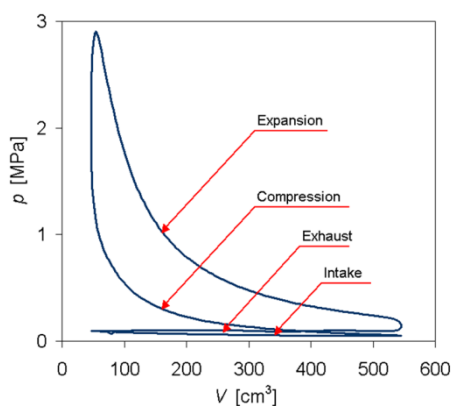

Fig. 2.3. Pressure-volume diagram of four-stroke spark-ignition engine at the medium engine load

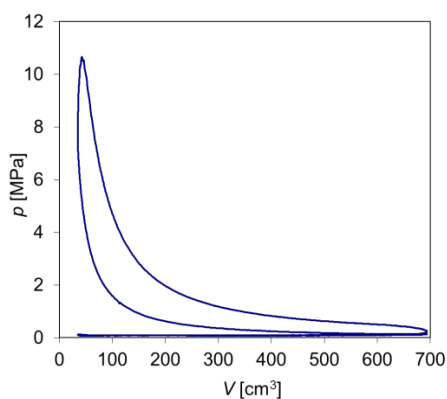

Fig. 2.4. Pressure-volume diagram of four-stroke compression-ignition engine with direct fuel injection at the medium engine load

3. THEORETICAL ENGINE CYCLES

The simplest model of the engine work cycle is a theoretical cycle presenting an idealized process of subsequent thermodynamic changes of the working fluid. Theoretical cycle will not be used to develop model of the engine in this course, but it allows us to understand the basic processes occurring in the engine cylinder and the method for converting the fuel's energy into mechanical work. The type

of theoretical cycle that is applicable to the description of the given actual engine depends on the method of heat introduction. The piston engines use three cycles:

- Otto cycle with the heat introduction at constant volume,
- Diesel cycle with the heat introduction at constant pressure,
- Sabathe cycle, where part of the heat is introduced at constant volume and the rest at constant pressure.

The above cycles are shown in p - V diagrams in figure 3.1.

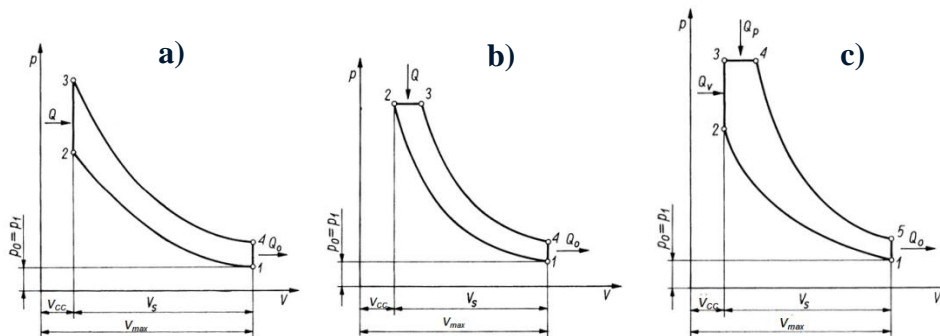

Fig. 3.1. Theoretical cycles; a) Otto, b) Diesel, c) Sabathe. Abbreviations: V_S – swept volume, V_{CC} – combustion chamber volume, Q_V – heat supplied at constant volume, Q_P – heat supplied at constant pressure

For the description of changes taking place in the cylinder of the engine with spark-ignition, the Otto cycle is widely used. Diesel cycle is used in low-speed engines with compression-ignition, while in the case of high-speed engines with compression-ignition and with significant participation of the kinetic combustion, the better mapping is provided by the Sabathe cycle.

Engine compression ratio is defined as:

$$CR = \frac{V_1}{V_2} = \frac{V_{\max}}{V_{CC}} = 1 + \frac{V_S}{V_{CC}} \quad (3.1)$$

Degree of pressure rise ratio due to the combustion is:

$$\alpha = \frac{p_3}{p_2}, \quad (3.2)$$

and the degree of volume rise ratio is:

$$\beta = \frac{V_4}{V_3}, \quad (3.3)$$

where the designations of cycle's characteristic points refer to fig. 3.1 c.

Gas molecules that comprise the working fluid are treated as an ideal gas. The basic relations between the gas parameters are described by the Clapeyron equation:

$$pV = mRT = m \frac{\tilde{R}}{M} T = n\tilde{R}T, \quad (3.4)$$

where: R – individual gas constant, \tilde{R} – universal gas constant = 8314 J/(kmol·K), M – average molar mass of the gas, n – number of gas moles.

Process of adiabatic compression (curve 1-2 in fig. 3.1) is described by the adiabatic equations:

$$p_1 V_1^\gamma = p_2 V_2^\gamma, \quad (3.5)$$

$$T_1 V_1^{\gamma-1} = T_2 V_2^{\gamma-1}, \quad (3.6)$$

$$\frac{p_1^{\frac{\gamma-1}{\gamma}}}{T_1} = \frac{p_2^{\frac{\gamma-1}{\gamma}}}{T_2}, \quad (3.7)$$

where: γ is the ratio of specific heats at constant pressure and at constant volume; $\gamma = c_p/c_v$. Analogical dependencies can be made for the expansion process.

Supplying the heat to the cycle at constant volume leads to a change in internal energy of the working fluid:

$$Q_V = mc_v(T_3 - T_2) = \frac{c_v}{R}(p_3 V_3 - p_2 V_2), \quad (3.8)$$

hence

$$Q_V = \frac{1}{\gamma-1} p_2 V_2 (\alpha - 1). \quad (3.9)$$

Supplying the heat at a constant pressure leads to a change in the medium's enthalpy (designations of cycle's characteristic points as in fig. 3.1c):

$$Q_p = mc_p(T_4 - T_3) = \frac{c_p}{R}(p_4 V_4 - p_3 V_3), \quad (3.10)$$

hence

$$Q_p = \frac{\gamma}{\gamma-1} p_2 V_2 \alpha (\beta - 1). \quad (3.11)$$

Total amount of the heat supplied to the Sabathe cycle is:

$$Q = \frac{p_2 V_2}{\gamma-1} [(\alpha - 1) + \gamma \alpha (\beta - 1)]. \quad (3.12)$$

The discharged heat, which in actual cycle is the enthalpy of the exhaust gas is:

$$Q_0 = mc_v(T_5 - T_1) = \frac{c_v}{R} V_1 (p_5 - p_1). \quad (3.13)$$

The work of any change at the elementary segment A-B is expressed as follows:

$$W_{A-B} = \int_{V_A}^{V_B} p dV. \quad (3.14)$$

The work of engine cycle is the area inside the closed diagram of engine cycle. On the example of Sabathe cycle (fig. 3.1c), the work of individual processes can be described with the use of the following set of equations:

$$W_{1-2} = \frac{p_2 V_2 - p_1 V_1}{\gamma-1} = \frac{p_2 V_2 (1 - (CR)^{1-\gamma})}{\gamma-1}, \quad (3.15)$$

$$W_{3-4} = p_3 (V_4 - V_3) = p_2 V_2 \alpha (\beta - 1), \quad (3.16)$$

$$W_{4-5} = \frac{p_4 V_4 - p_5 V_5}{\gamma - 1} = \frac{p_2 V_2 \alpha \beta}{\gamma - 1} (1 - (CR)^{1-\gamma}), \quad (3.17)$$

and the work of the whole cycle is:

$$W = W_{1-2} + W_{3-4} + W_{4-5}. \quad (3.18)$$

Average indicated pressure (IMEP) is one of the basic comparative parameters of the engine. This value is defined as a substitute constant pressure, which while acting on the piston during the time of one engine work stroke will perform the same work as the variable pressure during the whole cycle. In other words, it is the ratio of cycle volume work to the cylinder displacement:

$$\text{IMEP} = \frac{W}{V_s}. \quad (3.19)$$

Theoretical efficiency of the cycle is a ratio of the heat converted into the volume work to the amount of heat supplied to the cycle:

$$\eta = \frac{W}{Q_v + Q_p}. \quad (3.20)$$

$$\eta = \frac{W}{Q_v + Q_p}. \quad (3.20)$$

Due to the fact that cycle work is the difference of heat supplied to the cycle and the heat discharged from the cycle, the equation for efficiency takes the following form:

$$\eta = \frac{Q_v + Q_p - Q_0}{Q_v + Q_p} = 1 - \frac{Q_0}{Q_v + Q_p}. \quad (3.21)$$

Taking into account the equations 3.9, 3.11, 3.13 and the relations between thermodynamic parameters of the medium, the equation for theoretical efficiency of the cycle takes the following form.

$$\eta = 1 - (CR)^{1-\gamma} \frac{\alpha \beta^\gamma - 1}{(\alpha - 1) + \gamma \alpha (\beta - 1)}. \quad (3.22)$$

4. APPROACH TO MODELING

First stage of mathematical modeling of the engine work cycle is the determination of physical model of thermodynamic, flow, chemical phenomena, which make up this cycle. The next stage is the description of identified physical and chemical phenomena with the use of mathematical equations and their solution with the use of numerical methods.

Presented calculation model enables the determination of medium's thermodynamic parameters in the engine combustion chamber, identification of work indicators and energy balance. It is a zero-dimensional model, so all acquired parameters are averaged in regard to the volume of engine work



space. Presented description of the model concerns 4-stroke engine, but with minor modifications it can be applied to the 2-stroke engine. Structure of the model is shown in fig 4.1.

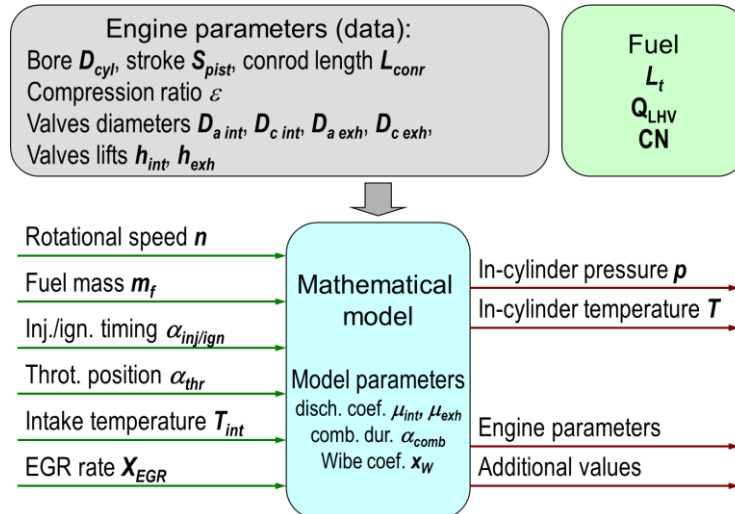

Fig. 4.1. Structure of mathematical model of the engine cycle

To accomplish the modeling task, you need to determine the following main dimensions of the engine and geometric parameters:

D_{cyl} – cylinder diameter,

S_{pist} – piston stroke,

L_{conr} – connecting rod length (measured between the axis of crank-pin and the axis of piston pin),

CR – compression ratio,

$D_{a\ int}$, $D_{c\ int}$, $D_{a\ exh}$, $D_{c\ exh}$ – characteristic diameters of intake and exhaust valves (marked in fig. 6.3),

h_{int} , h_{exh} – valve lifts,

Another input values are the fuel properties and parameters related to the method of its supplying, which will be discussed in the next subchapter.

Model calculations are divided into three separate stages:

- cylinder filling process,
- compression and expansion process, including the combustion,
- expansion process.

All calculations are performed under single operating condition, therefore engine rotational speed and thermodynamic parameters of the work medium in the intake runner, as well as exhaust runner should be determined. Calculations will be performed for one work cycle of the engine, every certain specific calculation step in the domain of crankshaft's rotation angle (e.g. every $1^\circ CA$).

5. PROPERTIES OF THE WORKING FLUIDS



KAPITAŁ LUDZKI
NARODOWA STRATEGIA SPÓJNOŚCI



UNIA EUROPEJSKA
EUROPEJSKI
FUNDUSZ SPOŁECZNY



Projekt współfinansowany ze środków Unii Europejskiej w ramach Europejskiego Funduszu Społecznego

Working fluid in the engine model is air. In regard to the atmospheric air, molar mass and individual gas constants are as follows:

$$M_{Air} = 29 \frac{kg}{kmol}, \quad R_{Air} = 287 \frac{J}{kg \cdot K}.$$

Operating medium will be treated as semi-ideal gas, while taking into account the dependence of the specific heat from the temperature, expressed with the following:

$$c_v = 1,372 \cdot 10^{-10} T^4 - 6,434 \cdot 10^{-7} T^3 + 1,014 \cdot 10^{-3} T^2 - 0,405 T + 756 \left[\frac{J}{kg \cdot K} \right] \quad (5.1)$$

where temperature T is in K. Obviously

$$c_p = c_v + R. \quad (5.2)$$

Relation of c_v and temperature is shown in figure 5.1.

Individual gas constant of stoichiometric exhaust of hydrocarbon fuels roughly does not differ from gas constant of the air. On the other hand, specific heat of the exhaust increases along with the temperature, more than in case of the air.

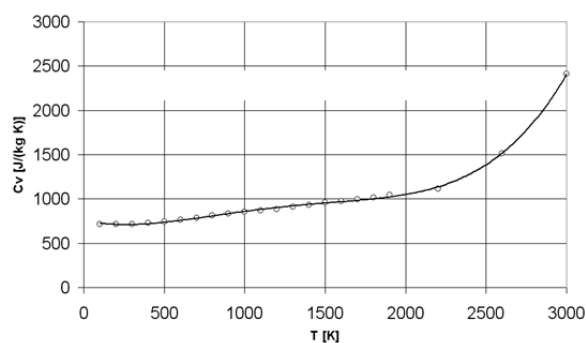

Fig. 5.1. Relation of the specific heat at a constant volume to the temperature

Due to fact that working fluid in the engine is a gas mixture, the following equations might be useful to perform calculations:

$$\frac{p_j}{p} = \frac{V_j}{V} = x_j \frac{M}{M_j} = \tilde{x}_j, \quad (5.3)$$

$$M = \frac{1}{n} \sum n_j M_j = \sum \tilde{x}_j M_j, \quad (5.4)$$

where: p_j – partial pressure of the j -th component, V_j/V – volume fraction, x_j – mass fraction, \tilde{x}_j – molar fraction.

When calculating the properties of air-fuel mixtures, the knowledge of basic properties of the fuel are needed. Table 5.1 shows the properties of common fuels that are necessary to conduct the calculations.

Table 5.1. Fuel properties



Fuel	Formula	$M \left[\frac{kg}{kmol} \right]$	$\left(\frac{A}{F} \right)_{stoi} [-]$	$Q_{LHV} \left[\frac{MJ}{kg} \right]$	$Q_{evap} \left[\frac{kJ}{kg} \right]$	$c \left[\frac{J}{kg \cdot K} \right]$	
						Liquid	Gas, c_p
Gasoline	$C_{7.76}H_{13.1}$	106	14.6	44	305	2400	1700
Diesel	$C_{10.8}H_{18.7}$	148	14.5	42.5	270	2200	1700
Natural gas	$CH_{3.8}$	18	14.5	45	510	–	2000
Propane	C_3H_8	44.1	15.7	46.4	426	2500	1600
n-Butane	C_4H_{10}	58.1	15.4		386		
Methanol	CH_3OH	32	6.47	20	1103	2600	1720
Ethanol	C_2H_5OH	46.1	9	26.9	840	2500	1930
Hydrogen	H_2	2.02	34.3	120	–	–	1440

6. GEOMETRY OF THE CRANK MECHANISM

Preparation of the model must begin by entering formulas for the temporary volume over the piston and temporary area of the combustion chamber (for the calculation of heat transfer). Engine dimensions and their designations are shown in figure 6.1.

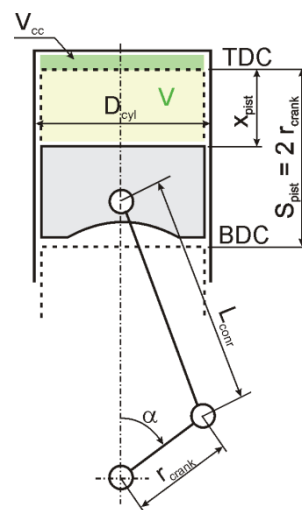

Fig. 6.1. Geometry of crank-piston system

Piston position is calculated from the following equation:



KAPITAŁ LUDZKI
NARODOWA STRATEGIA SPÓJNOŚCI



UNIA EUROPEJSKA
EUROPEJSKI
FUNDUSZ SPOŁECZNY



Projekt współfinansowany ze środków Unii Europejskiej w ramach Europejskiego Funduszu Społecznego

$$x_{pist,i} = r_{crank} \left(1 - \cos \alpha_i + 0,5 \cdot \frac{r_{crank}}{l_{conr}} \cdot \sin^2 \alpha_i \right) \quad (6.1)$$

Temporary volume over the piston is:

$$V_i = x_{pist,i} \cdot \frac{\pi \cdot D_{cyl}^2}{4} + V_{cc} \quad (6.2)$$

Indexes i represent current calculation step (current examined position of the crankshaft).

Examples of the calculation results for volume over the piston for the first 180 ° of crankshaft rotation are shown in fig. 6.2.

To simplify the calculations of heat transfer area, it can be assumed that the shape of combustion chamber is the surface area of a simple cylinder.

$$A_i = \frac{\pi \cdot D_{cyl}^2}{2} + \pi \cdot D_{cyl} \cdot x_{pist,i} \quad (6.3)$$

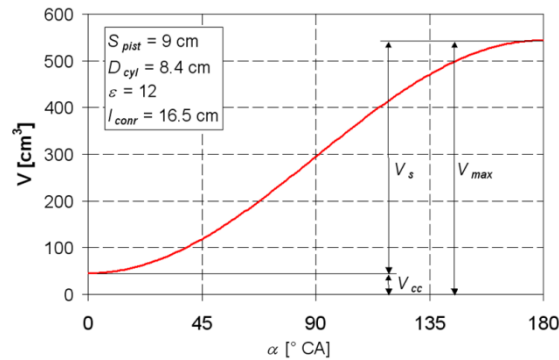

Fig. 6.2. Volume over the piston as a function of crankshaft rotation angle

The next stage of model preparation is to determine the temporary area of cross-sectional flow through the valves. Sectional area of the flow through the valve can be calculated based on the following equation:

$$f = \begin{cases} \pi \frac{D_c + D_a}{2} \sqrt{\left(h - \frac{D_c - D_a}{2 \cdot \tan \alpha} \right)^2 + \left(\frac{D_c - D_a}{2} \right)^2} & \text{dla } h > h_{cr}, \\ \pi \cdot h \cdot \sin \alpha (D_a + h \cdot \sin \alpha \cdot \cos \alpha) & \text{dla } h \leq h_{cr} \end{cases} \quad (6.4)$$

where

$$h_{cr} = \frac{D_c - D_a}{\sin 2\alpha} \quad (6.5)$$

Designations of valve dimensions are shown in fig. 6.3. In the majority of engines, valve seat angle α is 45 °, although there are exemptions to this rule. The width of the sealing edge of the valve seat s must be determined based on the figures of the modeled engine (for small engines of the passenger cars $s = 1.5\text{--}1.8$ mm).

Actual section of the stream of flowing medium and the mass flow rates are slightly smaller than those resulting from geometry of the valve, therefore there is a need to introduce the flow coefficient:

$$\mu = \frac{\dot{m}_{actual}}{\dot{m}_{ideal}} \quad (6.6)$$

During the rotation of crankshaft, both valve lift h and flow coefficient μ are changing. Therefore during the performance of calculations, it is convenient to use a constant (maximum) valve lift and variable flow coefficient, which will take into account two above-mentioned factors. Exemplary results for the experimental coefficient measurements of the flow through the intake valve are shown in fig 6.4.

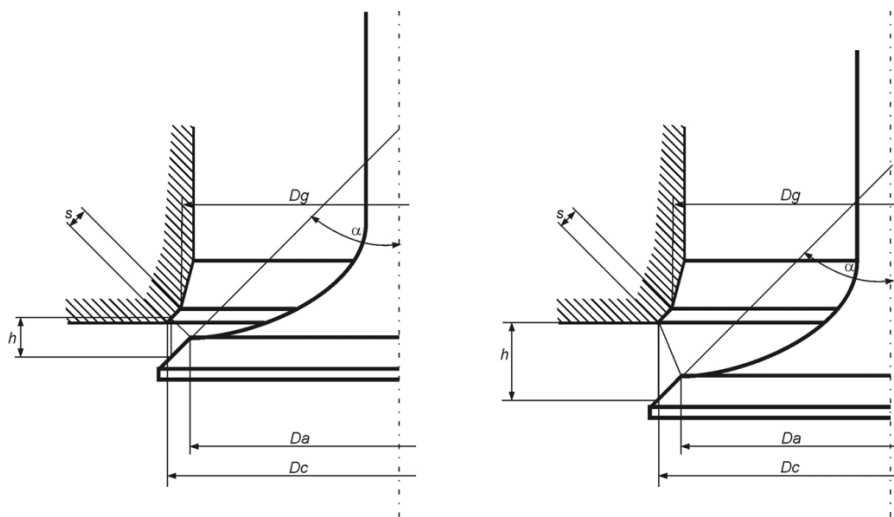

Fig. 6.3. Dimensions of valve

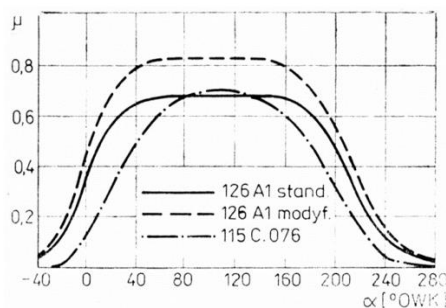

Fig. 6.4. Exemplary measurement and calculation results of the flow coefficient in regard to the maximum valve lift

For rough approximation of the flow coefficient's curve the following formula can be used:

$$\mu = \mu_{max} \left(1 - e^{-6.908 \cdot y^{1+a}} \right) \quad (6.7)$$

where a parameter controls steepness of the characteristic. Variable y increases linearly from 0 at the moment of valve opening, up to 1 in the moment of maximum lift, and then it decreases to 0 in the moment of valve closing. This variable must be calculated with the use of ratio based on the crankshaft rotation angle. Exemplary results of the calculations for $a = 1.5$ and $\mu_{max} = 0.8$ are shown in fig. 6.5. In

the example, the zero phases of the camshaft were deliberately selected, which is recommended if the flow dynamics are not taken into account in the calculations.

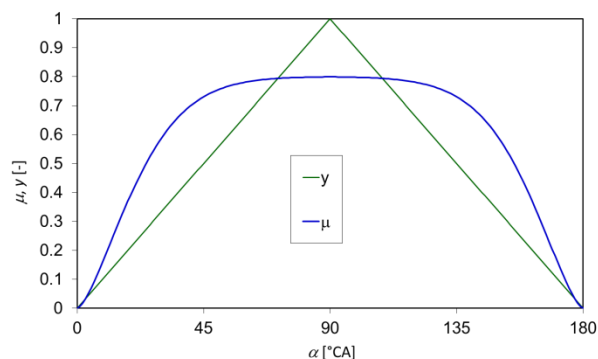

Fig. 6.5. Exemplary results for the coefficient calculations of the flow through the valve for $\mu_{max} = 0.8$ and $a = 1.5$

All calculations will be carried out for the specific rotational speed of the crankshaft. In order to convert the calculated streams of mass and heat into finite differences, it is necessary to introduce the constant value for duration of one calculation step in the following form::

$$\Delta t = \frac{\Delta \alpha}{6n} [s], \quad (6.8)$$

where n – rotational speed in 1/min, and $\Delta \alpha$ - calculation step in °CA.

7. INTAKE PROCESS

Prior to the carrying out of the calculations regarding the flow of the medium through intake valves, it is necessary to determine thermodynamic parameters of the medium in the intake runner. In the presented model it is assumed that these parameters (pressure and temperature) and the composition are constant. In the case of naturally-aspirated compression-ignition engine or spark-ignition engine and with fully opened throttle, the pressure in the intake channel is almost atmospheric. To determine pressure when throttle is partially closed, we can create an additional submodel of the flow or use the results of the empirical research. Temperature in the intake runners of the naturally-aspirated engines is usually a few degrees higher, than the ambient temperature. In the case of boosted engines, the pressure in the intake system should be increased to achieve the desired level of charging. Temperature of the medium behind the compressor can be calculated with the use of adiabatic compression equation (3.7). If the intercooler has been used, then the temperature of the medium should be accordingly decreased. Specific heat c_p of the medium in the intake system should be calculated based on the equations 5.1 and 5.2. Engine scheme for the needs of modeling of the intake process is shown in fig. 7.1.

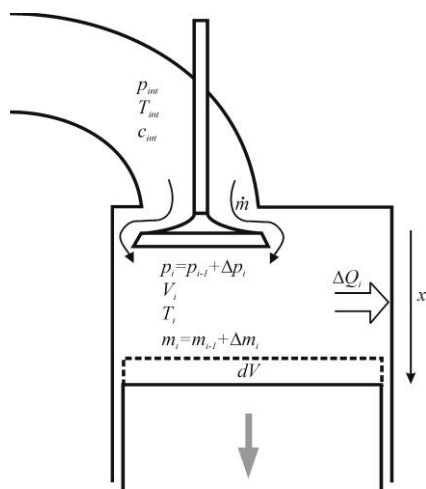

Fig. 7.1. Schematic of the engine for the modeling of intake process

To calculate the mass flow through the valve, we need to implement the commonly used St. Venant-Wanzel formula, describing isentropic subsonic flow through the convergent nozzle. Taking into account the assumed flow coefficient, the actual mass flow of the medium can be expressed with the use of the following equation:

$$\dot{m}_i = \begin{cases} \frac{\mu_{\text{int},i} f_{\text{int}} P_{\text{int}}}{\sqrt{RT_{\text{int}}}} \left(\frac{P_i}{P_{\text{int}}} \right)^{\frac{1}{\gamma}} \sqrt{\frac{2\gamma}{\gamma-1} \left[1 - \left(\frac{P_i}{P_{\text{int}}} \right)^{\frac{\gamma-1}{\gamma}} \right]} dA \frac{P_{\text{int}}}{P_i} < \beta_{cr} \\ \mu_{\text{int},i} f_{\text{int}} P_{\text{int}} \sqrt{\frac{\gamma}{RT_{\text{int}}} \left(\frac{2}{\gamma+1} \right)^{\frac{\gamma+1}{\gamma-1}}} dA \frac{P_{\text{int}}}{P_i} \geq \beta_{cr} \end{cases} \quad (7.1)$$

where the critical pressure ratio is $\beta_{cr} = \left(\frac{\gamma+1}{2} \right)^{\frac{\gamma}{\gamma-1}}$. (7.2)

Finite difference of mass of the medium flowing into the cylinder during the given calculation step can be expressed as:

$$\Delta m_i = \dot{m}_i \cdot \Delta t. \quad (7.3)$$

The total mass in the engine cylinder is calculated by numerical integration of the finite mass increases:

$$m_i = m_{i-1} + \Delta m_i. \quad (7.4)$$

Since the pressure changes in the cylinder during the intake stroke are not significant, for the calculation of temperature in the cylinder enthalpy balance can be used:

$$T_i = \frac{H_{i-1} + \Delta H_{\text{int},i-1} + \Delta Q_{\text{ht},i}}{m_i \cdot c_{p_{i-1}}}. \quad (7.5)$$

Taking into account formulas for enthalpies, equation 7.5 takes the following form:

$$T_i = \frac{m_{i-1} \cdot c_{p_{i-1}} \cdot T_{i-1} + \Delta m_i \cdot c_{p_{\text{int}}} \cdot T_{\text{int}} + \Delta Q_{\text{ht},i}}{m_i \cdot c_{p_{i-1}}}. \quad (7.6)$$

It should be noted that there is a component $\Delta Q_{\text{ht},i}$ in the balanced equation, which expresses the amount of heat transferred between the working fluid and the walls of the combustion chamber. At the initial stage of model preparation this value may be omitted. Heat transfer will be discussed in chapter 10.

To follow pressure trace during the intake stroke, it is convenient to use the gas equation of state. The formula for the finite pressure increase takes the following form:

$$\Delta p_i = \frac{RT_i}{V_i} \cdot \Delta m_{i-1} - \frac{P_{i-1}}{V_i} (V_i - V_{i-1}), \quad (7.7)$$

and the pressure in the cylinder is:

$$p_i = p_{i-1} + \Delta p_i. \quad (7.8)$$

It should be noted that in the first calculation step there are no previous values of the variables with index $i-1$. Therefore, it is necessary to determine the initial conditions prior to the implementation of calculation cycle. Before the first start of calculation cycle, the initial temperature and pressure in the cylinder must be preliminarily assumed. Then, in a few iterations as initial values we need to enter the values obtained after the finished implementation of the calculation cycle. Due to the fact that thermodynamic parameters of the medium in the cylinder fulfill the ideal gas equation of state, the

initial mass (mass of the residuals in the cylinder) can be calculated with the use of the ideal gas equation of state:

$$m_0 = \frac{p_0 V_0}{RT_0}, \quad (7.9)$$

where index 0 means the first calculation step (top dead centre of the piston in the intake stroke).

Figures 7.2 and 7.3 show exemplary results of the intake process calculations.

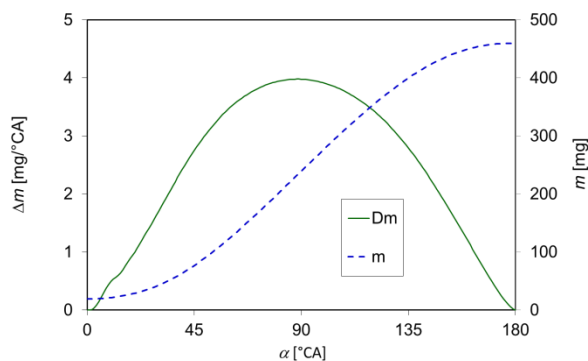

Fig. 7.2. Mass flow rate and cumulated mass in the gasoline engine cylinder during the intake process;
 $V_s = 500 \text{ cm}^3$, $n = 6000 \text{ 1/min}$, full load

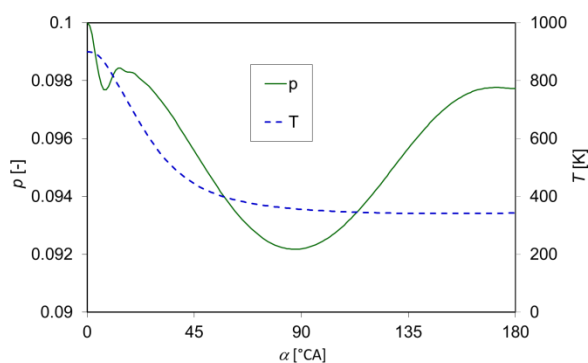

Fig. 7.2. Pressure and temperature in the gasoline engine cylinder during the intake process; $V_s = 500 \text{ cm}^3$,
 $n = 6000 \text{ 1/min}$, full load

8. COMPRESSION, COMBUSTION AND EXPANSION

Compression, combustion and expansion processes, apart from the issue of fuel supply, occur in the closed thermodynamic system. Engine schematic for the purpose of modeling the compression, combustion and expansion process is shown in fig. 8.1.

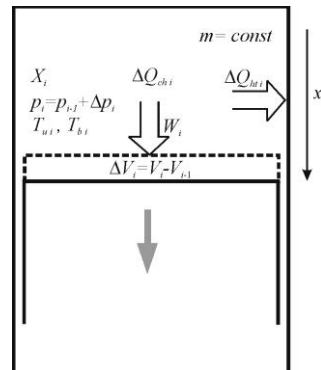

Fig. 8.1. Schematic of the engine for the modeling of the intake process

To determine the parameters of the medium, the ideal gas equation of state and the first law of thermodynamics are used:

$$dU = \partial Q - \partial W. \quad (8.1)$$

Numerically, based on the first law of thermodynamics, finite pressure increase in the calculation step can be expressed as:

$$\Delta p_i = \frac{1}{V_i} \cdot [(\kappa_i - 1) \cdot (\Delta Q_{ch,i} + \Delta Q_{ht,i}) - \kappa_i \cdot p_{i-1} \cdot (V_i - V_{i-1})], \quad (8.2)$$

and pressure in the cylinder is:

$$p_i = p_{i-1} + \Delta p_i. \quad (8.3)$$

Averaged temperature in the cylinder is:

$$T_i = \frac{p_i V_i}{m_i R}. \quad (8.4)$$

In order to determine the amount of heat supplied to the cycle in each calculation step $Q_{ch,i}$ we need to know the total amount of heat released in the cylinder from the supplied fuel dose and the heat release rate. The amount of fuel in the engine cylinder results from the amount of air or mixture, which flew through the intake valve. If in the intake system there was an air-fuel mixture of a specific composition, then the fuel mass is known. If the fuel is supplied directly to the cylinder, its amount results from the assumed air excess ratio λ , and is:

$$m_F = \frac{m_{Air}}{\lambda(A/F)_{stoi}}. \quad (8.5)$$

If the cylinder is filled with pure air, then its mass after the closing of intake valve amounts to:

$$m_{Air} = m_{IVC} - m_{IVO}, \quad (8.6)$$

where IVO and IVC indexes correspond to the position of the crankshaft, respectively during the opening and closing of the intake valve.

The total amount of heat released during the combustion process, assuming the total and complete combustion, is:

$$Q_{ch} = m_F \cdot Q_{LHV}. \quad (8.7)$$

This model is based on the assumed course of heat release. The most widely used formula for determination of the combustion progress (mass fraction burnt of fuel) is the form proposed by Wiebe:

$$x_b = 1 - \exp \left[-6.908 \left(\frac{\alpha - \alpha_{SOC}}{\alpha_{EOC} - \alpha_{SOC}} \right)^{m+1} \right], \quad (8.8)$$

where α_{SOC} and α_{EOC} respectively mean the crankshaft rotation angles that correspond to the start and the end of combustion. The total combustion angle usually amounts to 50–60 °CA. Exponent m is used for the shaping of combustion dynamics (fig. 8.2). Generally, for the spark-ignition engines, the exponent assumes the values from the range $1 < m < 2$, and for the compression-ignition engines from the range $0.2 < m < 1$. In the case of compression-ignition engines, in order to distinguish phases of kinetic and diffusion combustion, it is possible to use double Wiebe function.

The amount of heat supplied for the working fluid during single calculation step is:

$$\Delta Q_{ch,i} = Q_{ch}(x_{b,i} - x_{b,i-1}). \quad (8.9)$$

The figures 8.2 and 8.3 show exemplary process of heat release and calculations results of pressure and temperature.

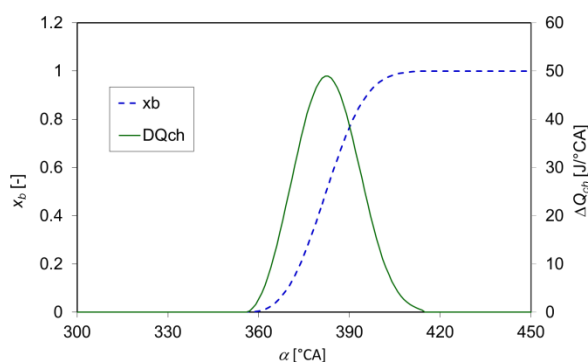

Fig. 8.2. Mass fraction burnt of fuel dose and the rate of heat release for the gasoline engine; $V_s = 500 \text{ cm}^3$, $n = 6000 \text{ 1/min}$, full load

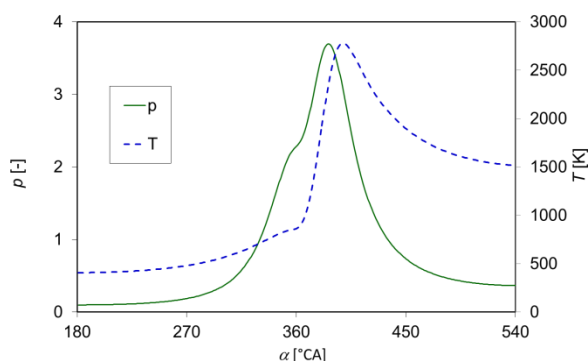

Fig. 8.3. In-cylinder pressure and temperature of the gasoline engine; $V_s = 500 \text{ cm}^3$, $n = 6000 \text{ 1/min}$, full load

9. EXHAUST PROCESS

Schematic of the engine for the modeling purposes of exhaust process is shown in fig. 9.1.

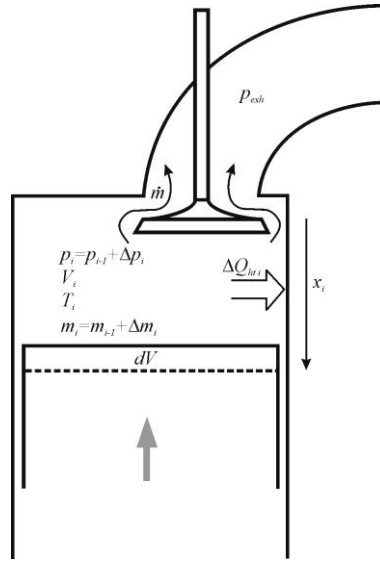

Fig. 9.1. Schematic of the engine assumed for the modeling of exhaust process

To calculate the mass flow rate through the exhaust valve, likewise in the case of intake, St. Venant-Wantzel formula is used. Flow coefficient as a function of crankshaft rotation must be calculated in accordance with the procedure described in chapter 6. The flow equation for the exhaust process takes the following form:

$$m_i = \begin{cases} \frac{\mu_{exh,i} f_{exh} p_i}{\sqrt{RT_{i-1}}} \left(\frac{p_{exh}}{p_i} \right)^{\frac{1}{\gamma}} \sqrt{\frac{2\gamma}{\gamma-1} \left[1 - \left(\frac{p_{exh}}{p_i} \right)^{\frac{\gamma-1}{\gamma}} \right]} & \text{for } \frac{p_i}{p_{exh}} < \beta_{cr} \\ \mu_{exh,i} f_{exh} p_i \sqrt{\frac{\gamma}{RT_{i-1}} \left(\frac{2}{\gamma+1} \right)^{\frac{\gamma+1}{\gamma-1}}} & \text{for } \frac{p_i}{p_{exh}} \geq \beta_{cr} \end{cases} \quad (9.1)$$

where the critical pressure ratio is $\beta_{cr} = \left(\frac{\gamma+1}{2} \right)^{\frac{\gamma}{\gamma-1}}$. (9.2)

Exponent γ in the above-mentioned equations refers to the medium in the cylinder. For the calculation of exhaust process we just need one boundary condition: pressure in the exhaust runner p_{exh} . In the naturally-aspirated or mechanically supercharged engines this pressure is slightly higher than

atmospheric. In the case of turbocharged engine, the exhaust backpressure can be calculated from adiabatic compression equations of the compressor and the turbine, with the assumed efficiency.

Finite mass difference of the medium flowing out of the cylinder during given calculation step can be expressed as:

$$\Delta m_i = \dot{m}_i \cdot \Delta t \quad (9.3)$$

Total mass in the engine cylinder is calculated by subtracting the finite differences:

$$m_i = m_{i-1} - \Delta m_i \quad (9.4)$$

To follow the pressure trace during the exhaust stroke, it is convenient to use the gas equation of state. The formula for the finite difference of the pressure takes the following form:

$$\Delta p_i = p_{i-1} \left(\frac{\Delta m_{i-1}}{m_{i-1}} - \frac{V_i - V_{i-1}}{V_i} \right), \quad (9.5)$$

and pressure in the cylinder is:

$$p_i = p_{i-1} + \Delta p_i \quad (9.6)$$

Temperature in the cylinder can be calculated while taking into account only the heat losses through the walls of combustion chamber:

$$T_i = T_{i-1} \frac{\Delta Q_{ht,i}}{m_{i-1} \cdot c_{p,i-1}} \quad (9.7)$$

Figures 9.2 and 9.3 show exemplary calculations results of the exhaust process.

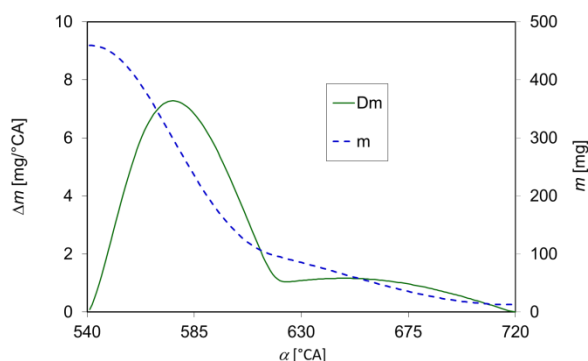

Fig. 9.2. Mass flow rate and cumulated mass in the gasoline engine cylinder during the exhaust process;

$$V_s = 500 \text{ cm}^3, n = 6000 \text{ 1/min, full load}$$

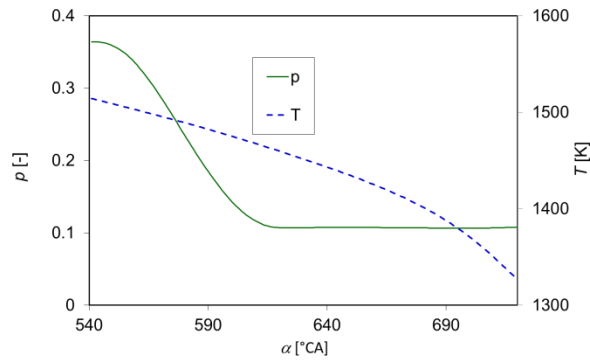

Fig. 9.3. In-cylinder pressure and temperature in the gasoline engine during the exhaust process;
 $V_s = 500 \text{ cm}^3$, $n = 6000 \text{ 1/min}$, full load

10. HEAT TRANSFER

In the zero-dimensional models we assume the averaged description of the heat transfer between the working fluid and the walls of combustion chamber. The stream of heat transferred between the liquid in temperature T and a solid in temperature T_w is expressed with the use of Newton equation:

$$\dot{Q}_{ht,i} = A_i \cdot h_i (T_w - T_i), \quad (10.1)$$

where: A_i – temporary value of the heat transfer surface area (equation 6.3), h_i – heat transfer coefficient. Amount of heat transferred during one calculation step is:

$$\Delta Q_{ht,i} = \dot{Q}_{ht,i} \cdot \Delta t. \quad (10.2)$$

Many empirical correlations of the heat transfer coefficient have been developed for the calculation purposes of the heat transfer in piston engines. Among them, the most commonly used is the Woschni equation in the following form:

$$h_i = 130 D_{cyl}^{-0.2} p_i^{0.8} T_i^{-0.53} \left[C_1 c_m + C_2 \frac{V_s T_{IVC}}{p_{IVC} V_{IVC}} (p_i - p_{mot,i}) \right], \quad (10.3)$$

where the parameters p_{IVC} , T_{IVC} , V_{IVC} means respectively pressure, temperature and volume of the cylinder at the time of intake valve closing, p_{mot} is the pressure in the cylinder obtained without the combustion, and c_m is an average speed of the piston. C_1 and C_2 constants can be assumed as follows:

$C_1 = 6.18$, $C_2 = 0$ during the charge exchange process,

$C_1 = 1.28$, $C_2 = 0$ during the compression process,

$C_1 = 6.18$, $C_2 = 0,00324$ during the combustion and expansion.

Figure 10.1 shows the exemplary calculation results of the heat transfer in the engine.

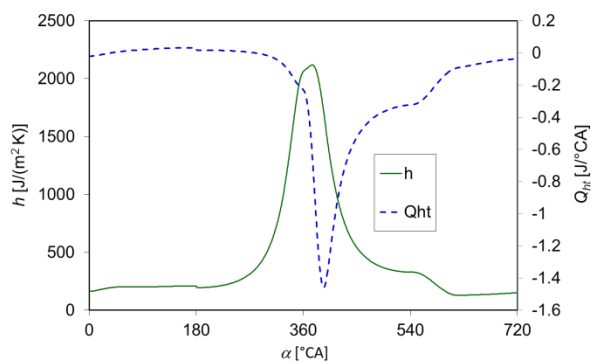

Fig. 10.1. Heat transfer coefficient and heat flow during full work cycle of the gasoline engine;
 $V_s = 500 \text{ cm}^3$, $n = 6000 \text{ 1/min}$, full load, $T_w = 500 \text{ K}$